

INSTALLATION INSTRUCTIONS

Model# 2758-01

1 LIGHT PENDANT

Warnings and Cautions

- Turn off electricity at circuit breaker or main fuse box before installation. Consult a licensed electrician if you are in doubt.
- These instructions are provided for your safety. It is very important you read them completely before installing fixture. We strongly recommend that a licensed, professional electrician perform the installation.
- Turn off the fixture at the wall switch before replacing bulbs.
 - Make sure bulbs are given sufficient time to cool before removal.
 - Do not subject glass parts to any shock while in operation or shattering may result.

Tools Required (Not Included): Flathead screwdriver, Phillips screwdriver, Wire cutters, Electrical tape, Safety goggles, Ladder.

Helpful Tools (not included): Wire strippers.

ASSEMBLY INSTRUCTIONS

1. Carefully unpack and lay all parts on a clean, level surface. Do not discard any contents until after assembly is complete to avoid accidentally discarding small parts or hardware.
2. Attach the threaded end of the short stem (k) into socket assembly (L), turning the stem in a clockwise direction till tight. Unscrew the pre-assembled lock ball nut (G) from the mounting bracket (B). Attach the mounting bracket (B) to the junction box (not included) with junction box screws (D).
3. Loosen the Allen Strain Relief Screw (H) from the threaded collar using the Allen Wrench (I) by turning the wrench counter-clockwise. Adjust the Power Cord (J) upwards or downwards through the canopy (F) until the desired suspension length is determined. Secure the power cord (J) in place by tightening the set screw in a clockwise motion (H) onto the collar. Do not over tighten the screw, making sure the power cord (J) will not slip downwards with the pendant body.

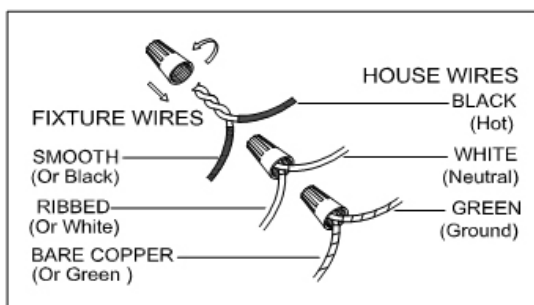
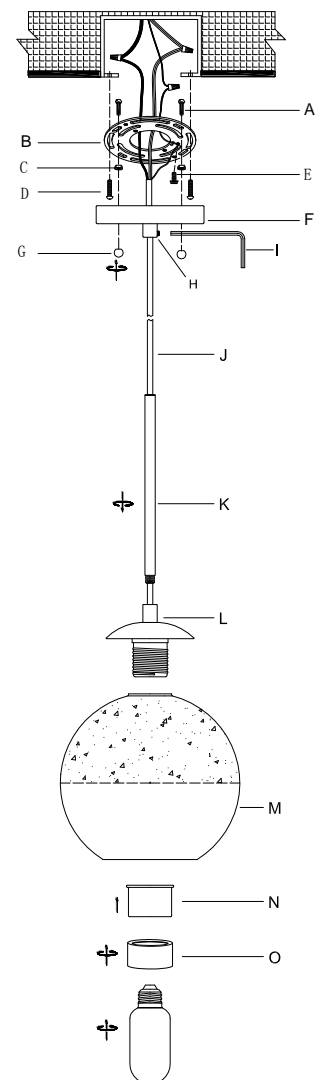

4. Use the wire connectors (supplied) to connect the wires (see diagram above). Connect the house ground wire to the fixture ground wire. Connect the house white wire to the fixture supply wire (ribbed sided). Connect the house black (or red) wire to the fixture supply wire (smooth side) Wrap each connection with approved electrical tape and carefully place all of the connected wires into the outlet box.
5. Place the canopy (F) up to the ceiling junction box, allowing the pre-assembled screws on mounting bracket (B) to pass through the canopy (F) and secure with locking ball nuts (G).
6. Remove the pre-assembled socket ring (O) and the spacer (N) from the socket assembly (L). Position the shade (M) and the spacer (N) over the socket, then secure with the socket ring (O).
7. Install the bulb (not included).
Install correct bulbs referring to fixture markings and/or labels for maximum wattage.
8. Your installation is now completed. Restore electricity to test for connectivity. If there are any issues turn power off at the circuit breaker and double check to make sure the wires are connected properly. Retain this sheet for future reference.

CLEANING AND MAINTENANCE

1. Wipe clean using soft, dry cloth or static duster.
2. Always avoid using harsh chemicals and abrasives to clean fixture as they may damage the finish.