

Sink Leonardo 38" x 20" – U/M - 1017 660

Sinks

Code: 1017 660

AISI 304 Stainless steel
Satin finish
Undermount
x cross bending for easy water draining



DETAILS

Series	Leonardo
Material	AISI 304 stainless steel
Finish	Satin finish
Thickness	16 Gauge (1.5 mm)
Inset type	Undermount
Overall dimensions	37 ³¹ / ₆₄ " x 19 ¹⁹ / ₆₄ "
Bowls dimensions	1 bowl 35 ⁶³ / ₆₄ " x 15 ³ / ₄ "
Bowls depht	10 "

Cut out	35 ⁶³ / ₆₄ " x 15 ³ / ₄ "
Waste fitting type	3 1/2" - with stainless steel basket
Bowls bottom	X cross bending for easy water draining
Underside	Protected with heavy duty undercoating
Fixing system	Undermount fixing kit (brass insert and clips)

FEATURES

Diamond-shape bottom	The draining of water is an important feature in a sink, and it's always taken good care of in Foster products. In the bent-welded sinks, which would have a flat bottom, the proper draining is guaranteed by the elegant beveling, which helps the water flow.
High thickness	1.5 mm thick steel. A significant thickness, which guarantees the maximum sturdiness and durability.
Basket 3,5" waste fitting	The drain is equipped with a large 3.5" drain, with the practical basket cap that prevents the discharge of solid parts. The 3.5 "drain allows the use of the Foster waste-disposer, compatible with all models.
Triple recess - sliding accessories	The Foster Milano sink has an ingenious design that makes it simple to use a large set of optional accessories. On the topmost supporting step, the innovative Black grids slide, creating a large and practical surface to rinse food and crockery. The second step is meant to support and allow the sliding of a complete combination of accessories, which make some operations practical and safe: rinse, drain, slice, grate... everything can be done inside the sink. The third supporting step is on the bottom of the bowl. On this step one can rest the Black grids, making it possible to rinse foodstuffs without their coming in contact with the bottom of the sink, which may be dirty.

TECHNICAL DATA

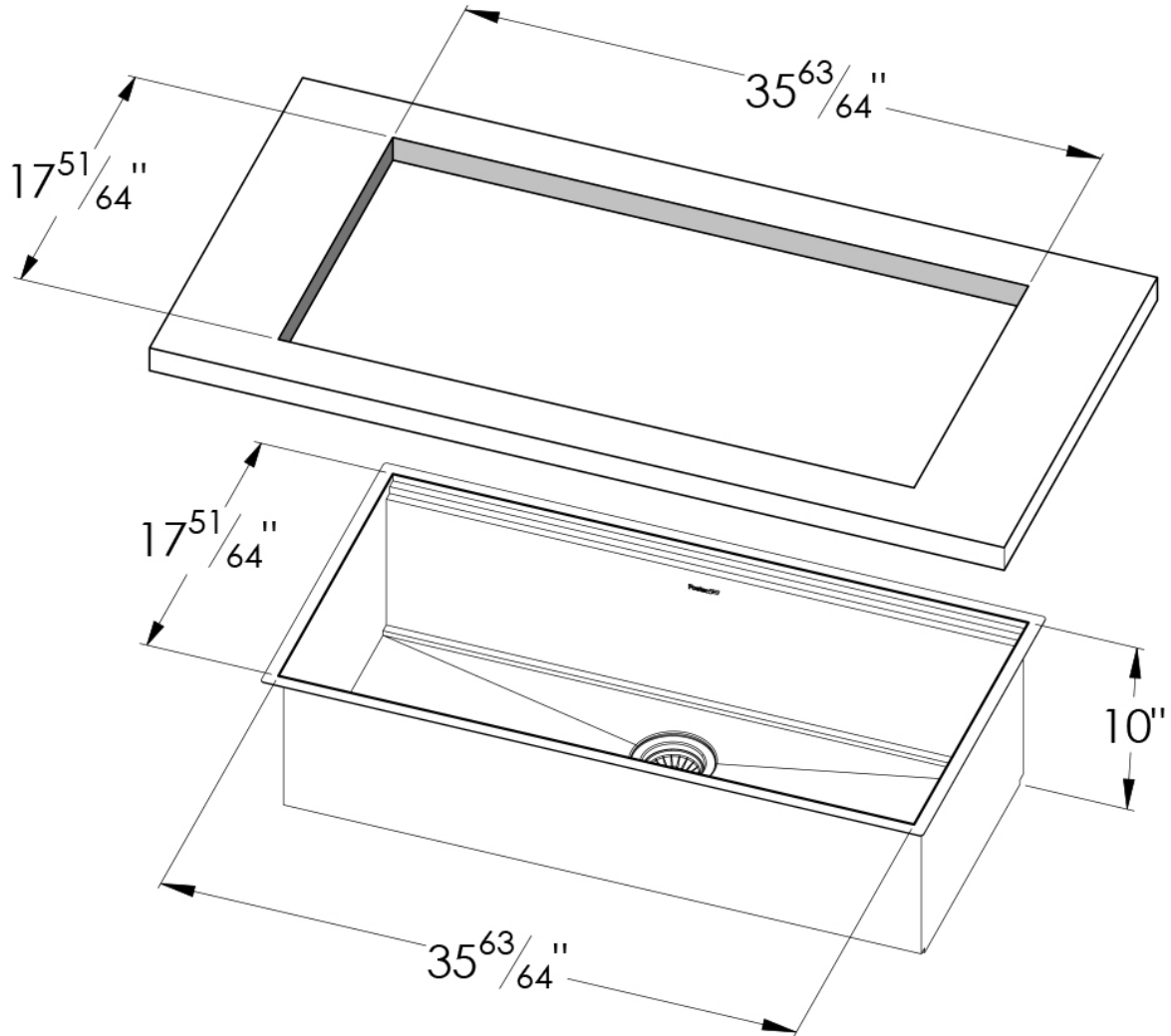

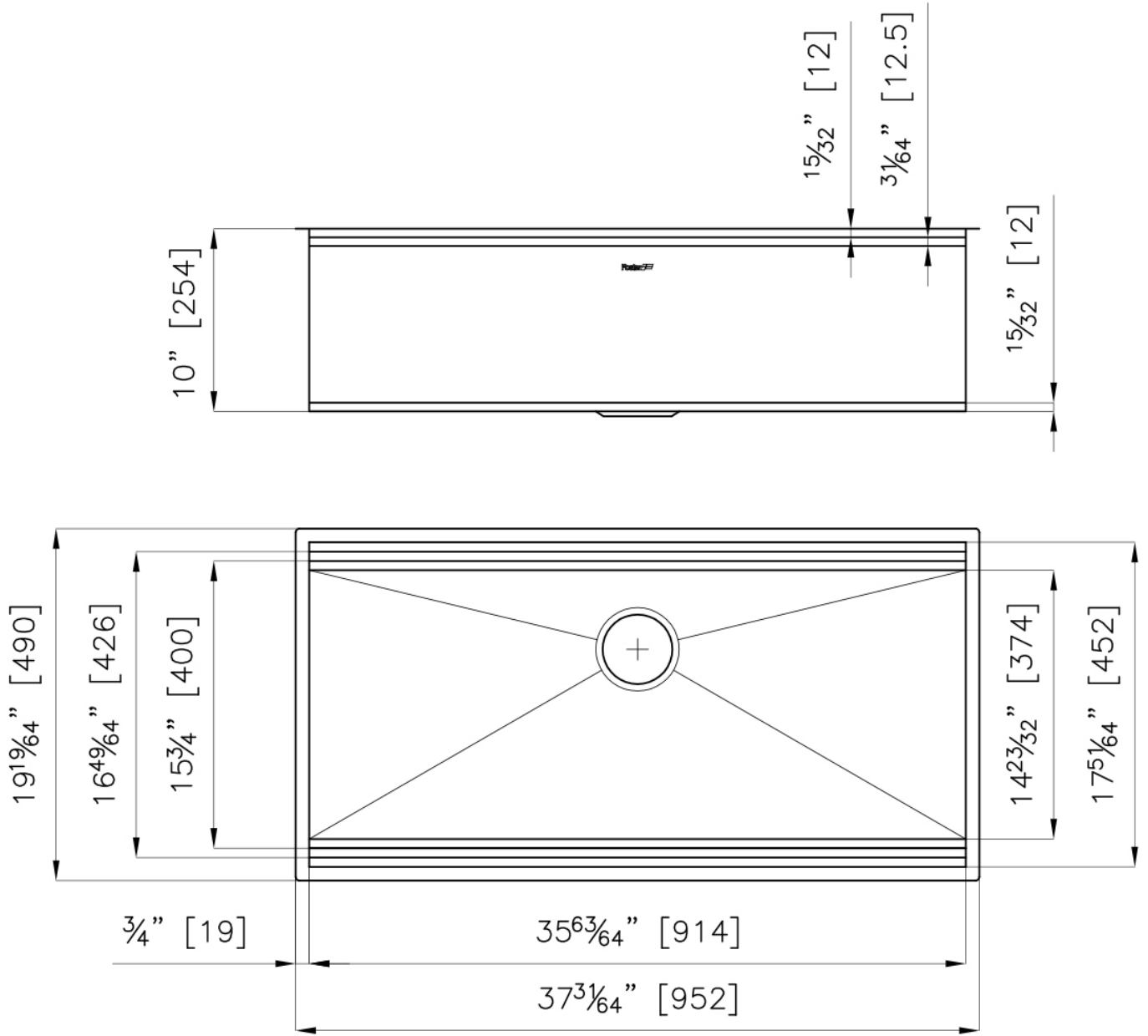

Edge
positioning

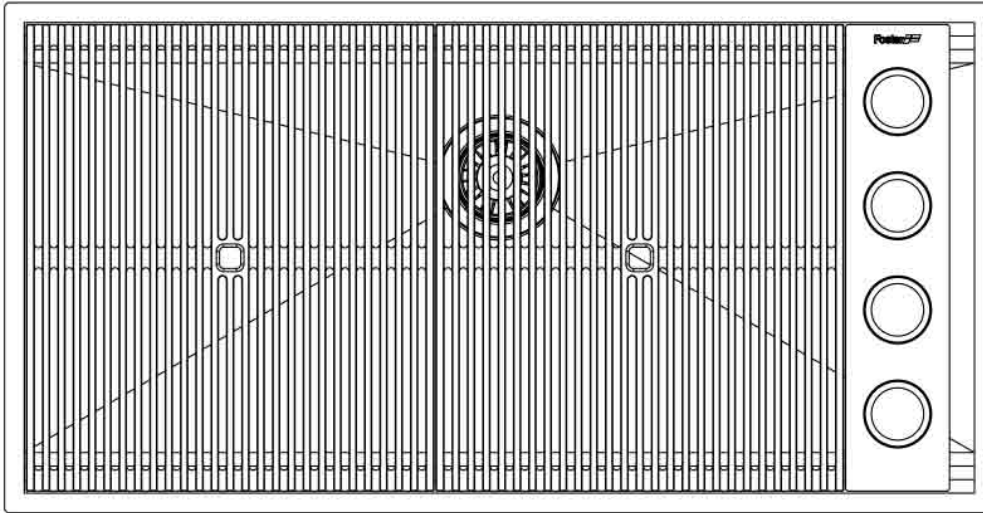

8100 601

8100 600

8100 620

8100 600

8100 600

Bottom
positioning

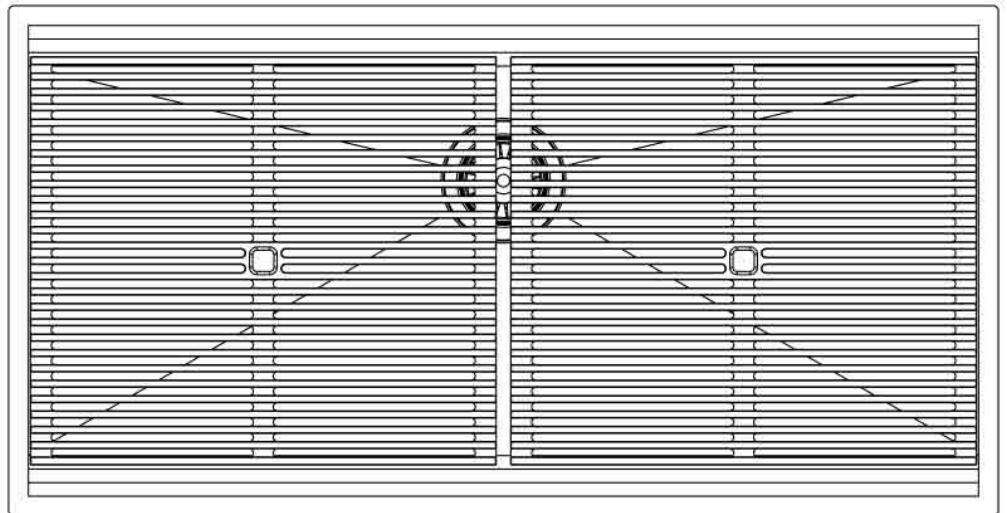

OPTIONAL ACCESSORIES



3 Bottles-holder set 8100 621



3 Bowls set 8100 622



4 Spices-holder set 8100 620



Black Grid 8100 600



Black Grid 8100 601



Chopping Board - 8642 000



Chopping Board 8631 300



Grating kit complete with ring support and food collection tray 8159 101

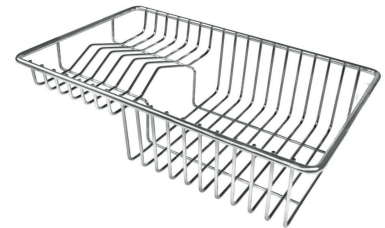

Stainless Steel dishes holder 8100 303



Stainless steel perforated pan 8151 000



Twin Chopping Board - 8644 101



White bowl 8153 100

WARNING:

The accessories 8159101, 8100303, 8151000 are only usable in combination with 8644101

RECOMMENDED PAIRINGS



Faucet Capri | Polished finish -
8467 005



Faucet Salina | Polished Finish -
8487 005

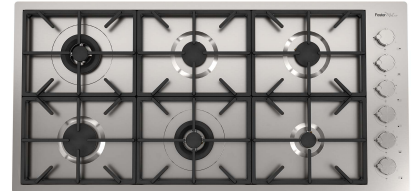

Milano Cooktop 6 burners - 7639
900

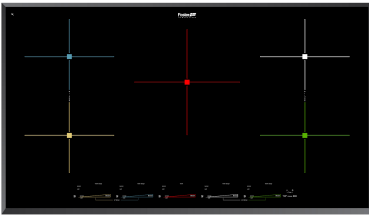

Milano Induction Cooktop 5 Plate
- 7390 945