

## Sink Happy Hour Gun Metal 49" x 20" – U/M - 1049 956

Sinks

Code: 1049 956

PVD Gun Metal coloring  
AISI 304 Stainless steel  
Satin finish  
Undermount  
x cross bending for easy water draining



### DETAILS

<b>Series</b>	Happy Hour
Coloring	Gun Metal
Finish	Satin finish
Finish	PVD
Material	AISI 304 stainless steel
Thickness	16 Gauge (1.5 mm)
Inset type	Undermount
Overall dimensions	48 <sup>21/32</sup> " x 19 <sup>51/64</sup> "

Bowls dimensions	1 bowl 46 <sup>21/32"</sup> x 17 <sup>51/64"</sup>
Bowls depht	10 "
Cut out	48 <sup>21/32"</sup> x 19 <sup>51/64"</sup>
Waste fitting type	3 <sup>1/2"</sup> - with stainless steel basket
Bowls bottom	X cross bending for easy water draining
Underside	Protected with heavy duty undercoating
Fixing system	Undermount fixing kit (brass insert and clips)

## FEATURES

Diamond-shape bottom	The draining of water is an important feature in a sink, and it's always taken good care of in Foster products. In the bent-welded sinks, which would have a flat bottom, the proper draining is guaranteed by the elegant beveling, which helps the water flow.
High thickness	1.5 mm thick steel. A significant thickness, which guarantees the maximum sturdiness and durability.
Basket 3,5" waste fitting	The drain is equipped with a large 3.5" drain, with the practical basket cap that prevents the discharge of solid parts. The 3.5 "drain allows the use of the Foster waste-disposer, compatible with all models.
Triple recess - sliding accessories	The Foster Milano sink has an ingenious design that makes it simple to use a large set of optional accessories. On the topmost supporting step, the innovative Black grids slide, creating a large and practical surface to rinse food and crockery. The second step is meant to support and allow the sliding of a complete combination of accessories, which make some operations practical and safe: rinse, drain, slice, grate... everything can be done inside the sink. The third supporting step is on the bottom of the bowl. On this step one can rest the Black grids, making it possible to rinse foodstuffs without their coming in contact with the bottom of the sink, which may be dirty.

## TECHNICAL DATA

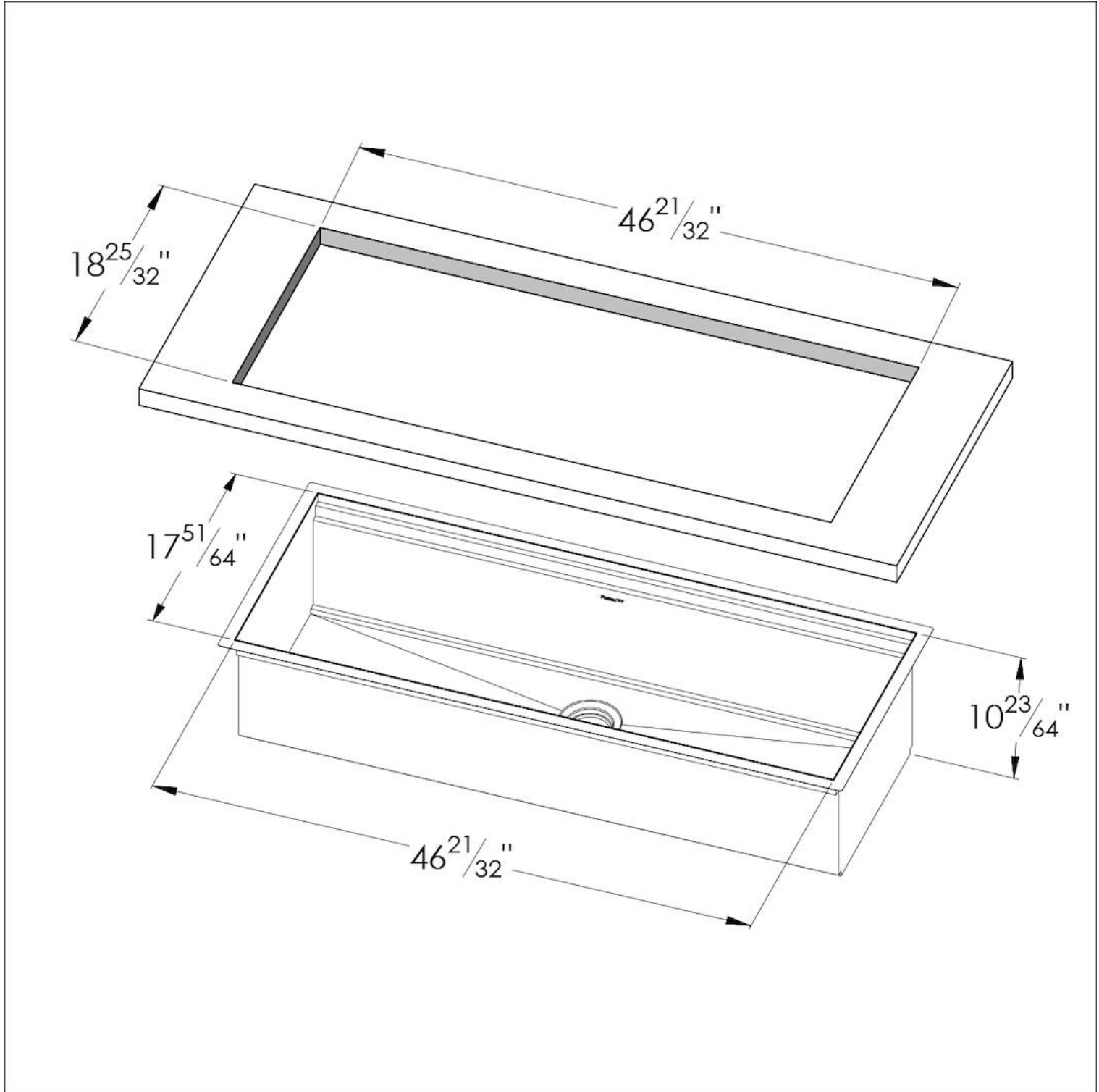

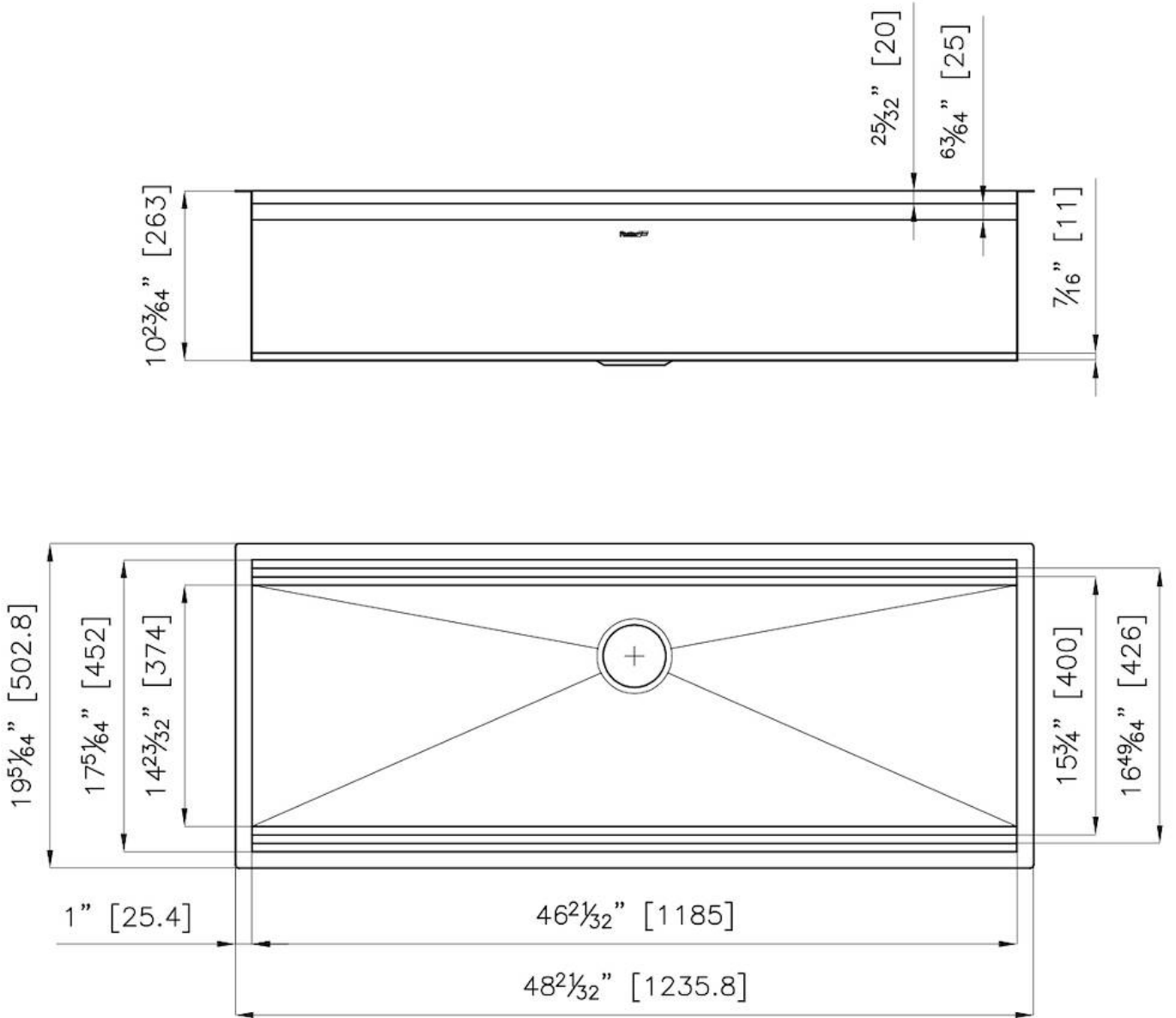

## Happy Hour Optional accessories

The "rails" system makes it possible use a combination of numerous accessories. Grids, chopping boards, utensils' ranging system, bowls and containers of different dimensions can be alternated in the workspace with a simple gesture, and can easily be stacked, in order to be on hand at all times.

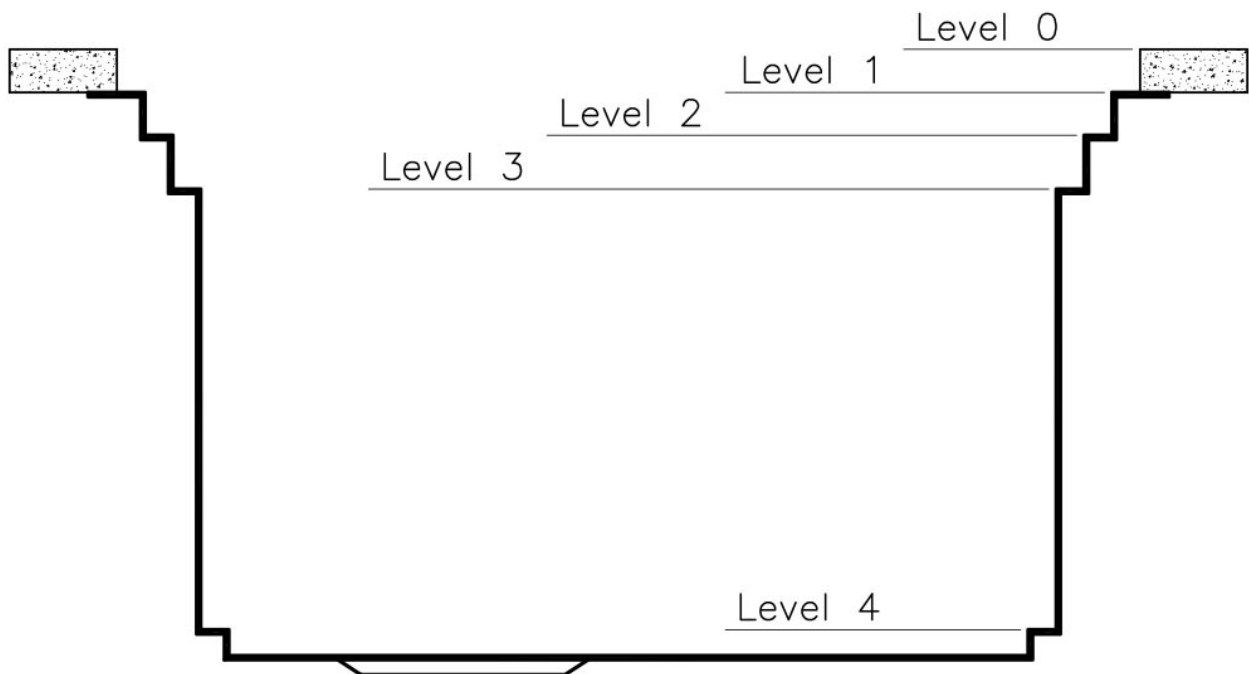

8100 600

8100 600

8100 600

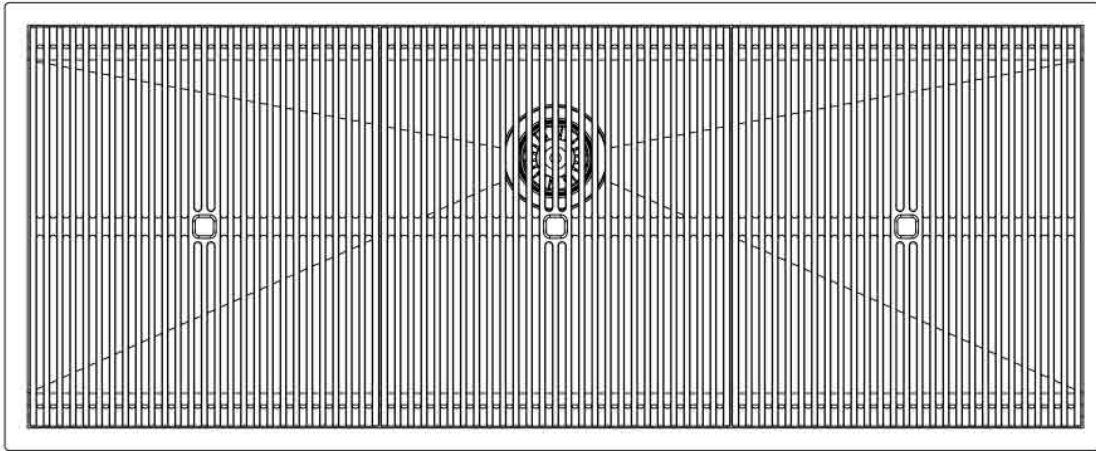

Edge positioning

Bottom positioning

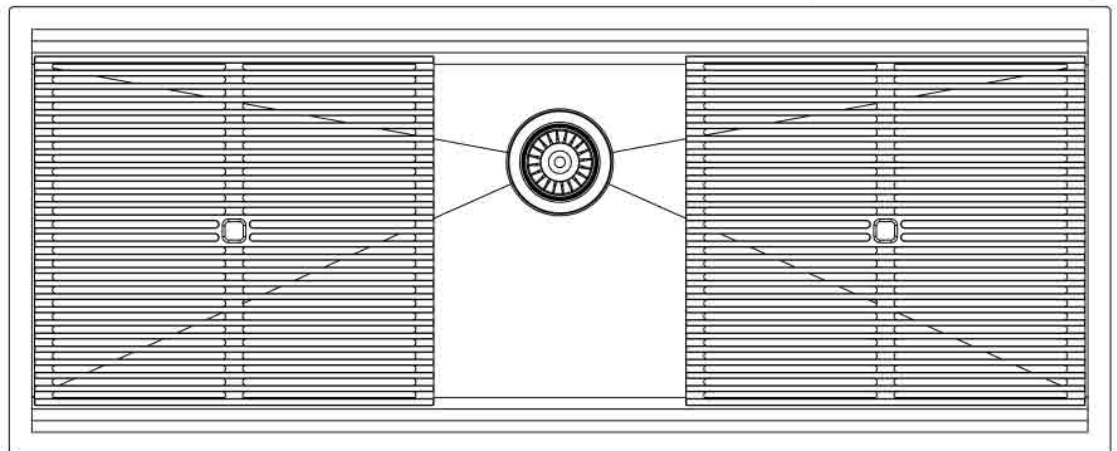

8100 600

8100 600

## GALLERY

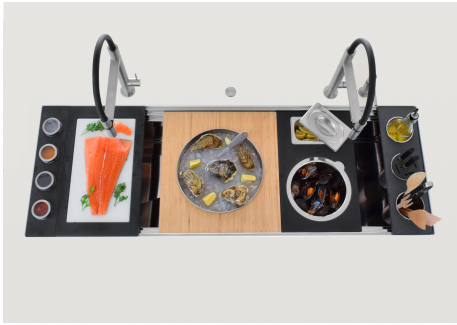
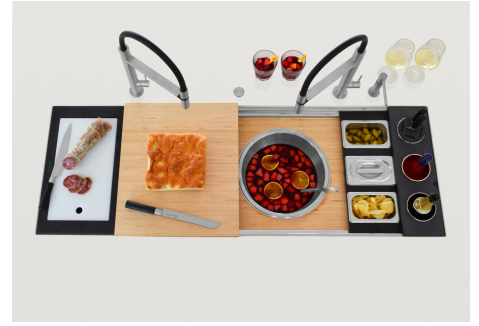

## OPTIONAL ACCESSORIES

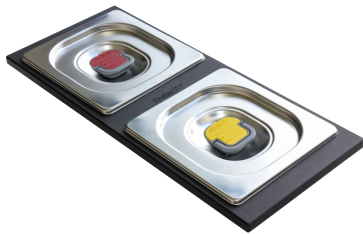

2 Bowls set 8100 623



3 Bottles-holder set 8100 621



3 Bottles-holder set 8100 626



3 Bowls set 8100 622



3 Bowls set 8100 624



4 Spices-holder set 8100 620



4 Spices-holder set 8100 625



Chopping Board - 8642 000



Chopping Board 8631 300



Grating kit complete with ring support and food collection tray 8159 101



HDPE + Black Twin chopping board 8100 627



Kit bowl Ø30 cm with bamboo support - 8200 601



Kit multi-bowl 8100 628



Knives-holder 8100 030

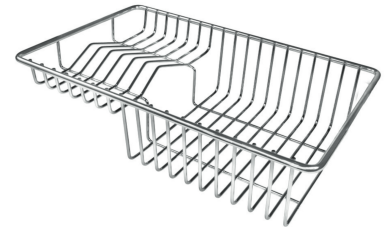

Stainless Steel dishes holder 8100 303



Stainless steel perforated pan 8151 000



Steel tray 1778 000



Twin Chopping Board - 8644 101





White bowl 8153 100



Bamboo chopping board 8200 002



Black Grid 8100 600

## WARNING:

- 1778 000 can only be used in combination with 8200 601;
- 8100 030 can only be used in combination with 8100 621 and 8100 626;
- 8151 000, 8159 101 and 8100 303 can only be used in combination with 8100 627.

## RECOMMENDED PAIRINGS

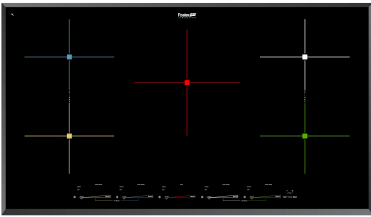

Milano Induction Cooktop 5 Plate - 7390 945



Faucet Capri Gun Metal - 8467 605

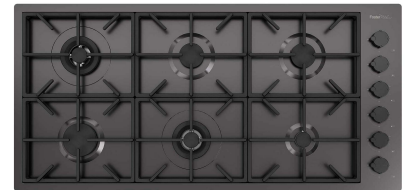

Milano Cooktop Gun Metal 6 burnes - 7639 906