

# HAMILTON SINKLER

---

## CK200 Cabinet Knob

### Standard Finishes:

- Antique Brass
- Brushed Nickel
- Oil Rubbed Bronze
- Polished Chrome
- Polished Nickel
- Satin Brass
- Polished Brass Unlacquered

Base Material:  
Solid Brass

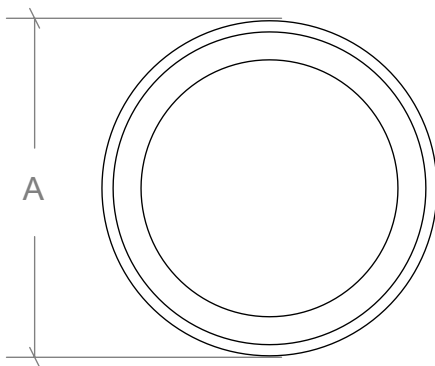

A: 1", 1-1/4", 1-1/2"

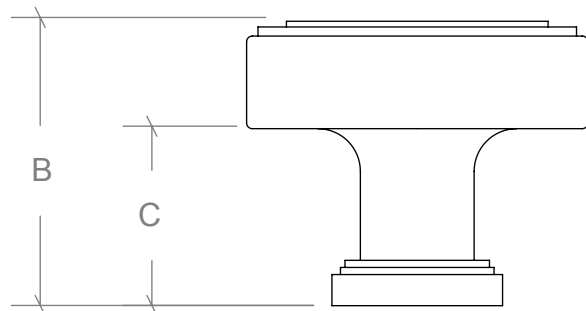

B: 7/8", 1", 1-1/4"

C: 1/2", 5/8", 3/4"