

JASON[®]

HYDROTHERAPY

8328 MacArthur Dr. • North Little Rock, AR 72118
 501.771.4477 • Fax: 501.771.2333
 Customer Service: 800.255.5766
 www.jasoninternational.com

Designer Collection Specifications

EM535

MicroSilk[®] - AirMasseur[®]

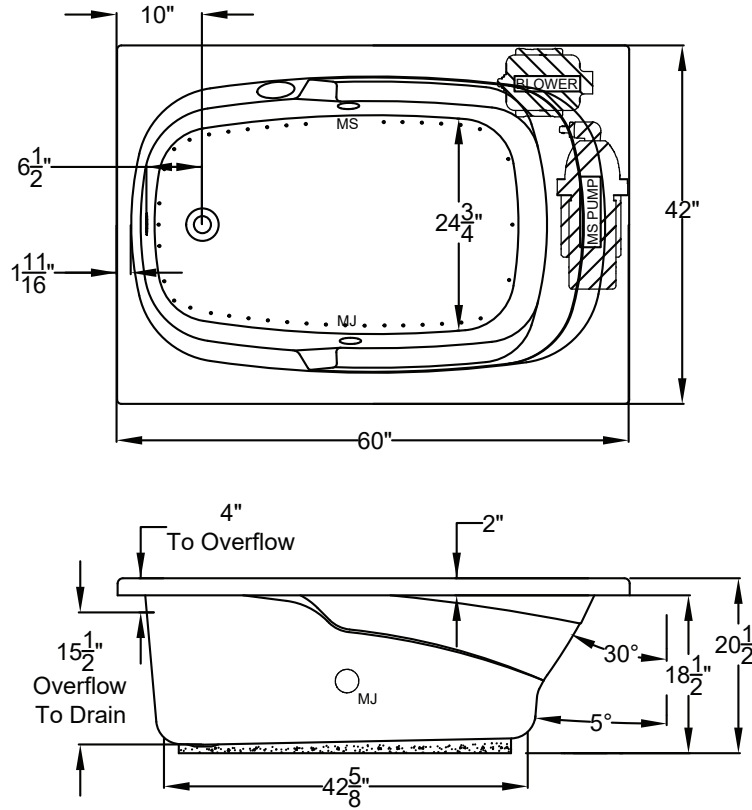

Patents recieved or pending.



Note: Dimensional Tolerances: ±1/4"

Drop-in-Hole Size:	40" x 58"
Operating Capacity:	44 Gal.
Overflow Capacity:	65 Gal.
Floor Loading / sq.ft.:	47.6 lbs.
Carton Weight:	150 lbs.
Cube:	36.2 ft. ³

REMOTE MOUNTING THE BLOWER:
 If an extension cord is required
 use a minimum 16 AWG cord
 with a maximum of 20ft length

Construction: Fiberglass reinforced acrylic bath with Level Form™ full-support base.

We provide products listed with Intertek ETL SEMKO (Edison Testing Laboratories) U.S. and Canadian and with International Association of Plumbing and Mechanical Officials (IAPMO). Consult factory with your listing requirements.

Standard		A 120V system that includes a MicroSilk [®] unit; a 1HP, variable speed air blower with integral air heater; automatic purge cycle; an electronic control that operated the MicroSilk [®] unit, blower, and blower speed for continuous, pulse or wave massage modes; and a 20-minute timer.
Premier		A 120V system that includes a MicroSilk [®] unit; a 1HP, variable speed air blower with integral air heater; automatic purge cycle; (2) Chromatherapy mood lights; Automatic Ozone System; an electronic control that operates the MicroSilk [®] Unit, blower and blower speed for continuous, pulse or wave massage modes; and a 20-minute timer.
Signature		A 120V system that includes a MicroSilk [®] unit; a 1HP, variable speed air blower with integral air heater; automatic purge cycle; (2) Chromatherapy mood lights; Automatic Ozone System; a digital control with LCD display; low water level and temperature sensors; enhanced user control options; a 20-minute timer; and Bluetooth Sound Immersion System. Control keypad operates the MicroSilk [®] unit, blower and blower speed for continuous, pulse or wave massage modes, LED Chromatherapy lights and shows MicroSilk [®] status, blower speed, water temperature and time remaining.