

## GLASGOW COLLECTION

### TOWEL BARS

390120

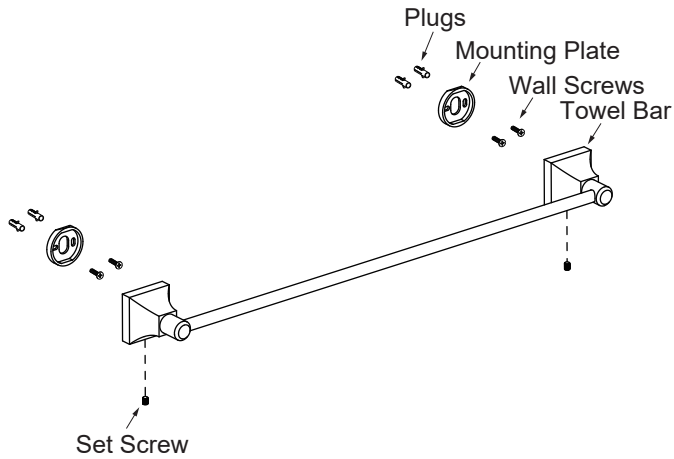

**Tools required for installation**

Level	Pencil
Screwdriver	Drill
	Hammer

**Step 1**

Loosen the set screw on the accessory and remove the backing plates. Position the accessory against the wall and mark outline with pencil.

**Step 2**

Position the backing plates flat side down on the wall and mark holes with pencil.

**Step 3**

Predrill 3/16" holes on the wall to fit wall plugs. Insert wall plugs into the wall. Position backing plates flat side down over the plugs and install screws.

**Step 4**

Slide the accessory onto the backing plates and tighten the set screws using Allen key provided.