

206-1.2S-__

Wall Mounted 2 Hole Lavatory Set

Requires SS-SHV1.2 concealed rough

Flow Rate: 1.2 GPM

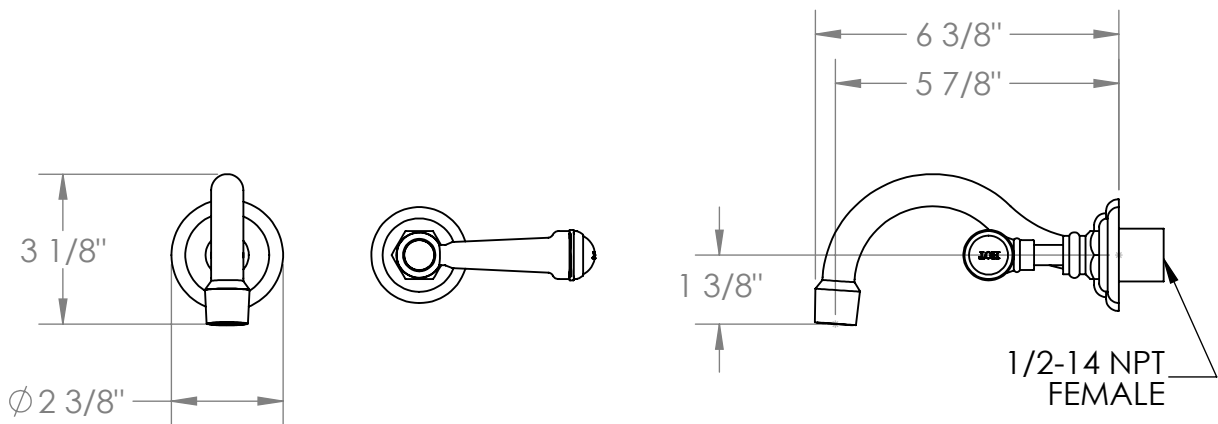

Meets the applicable requirements of ASME A12.18.1-2005/CSA B125.1-05, entitled "Plumbing Supply Fittings"

WATERMARK DESIGNS 1/28/2020

350 Dewitt Ave Brooklyn NY 11207 USA T 718 257 2800 F 718 257 2144 info@watermark-designs.com

HANDLE TRIM OPTIONS

S1 - PRESTON

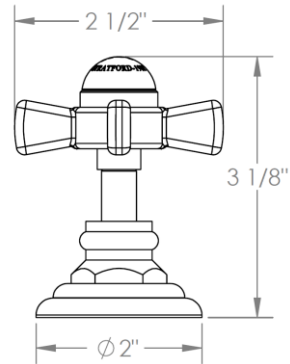

S2 - WALTHAM

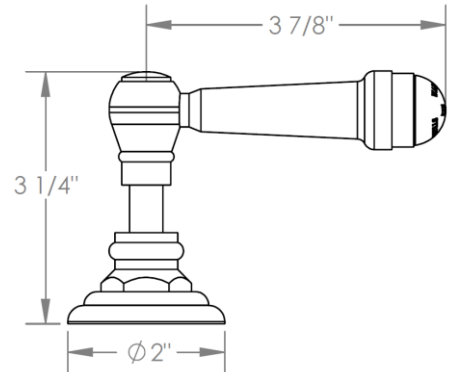

SWA - DARIEN

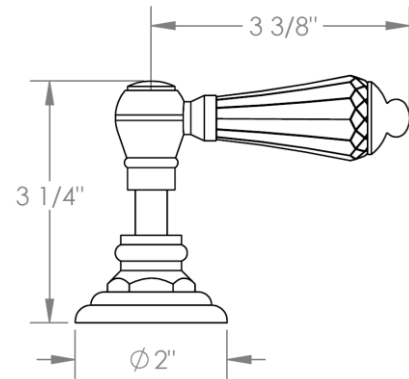

V - WALES

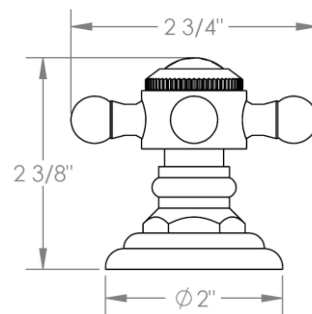

S1A – NOTTINGHAM

