



ACCURATE
LOCK & HARDWARE
AMERICAN CRAFTED SINCE 1972

2001ADAP Sliding Door Hardware Sets

ADA COMPLIANT SLIDING DOOR SOLUTIONS



ADA COMPLIANT SLIDING DOOR SETS

2001ADAP

Sliding and pocket doors can easily be ADA Compliant with the 2001ADAP Hardware Set. Furnished complete with ADA thumb turn, pull and industrial strength lock, this set offers compliance for space saving doors in commercial settings. Made entirely in the USA and available to ship in 2 days with the RMS Rapid Make + Ship Program.

2001ADAP SLIDING DOOR HARDWARE SET

2001ADAP FUNCTIONS

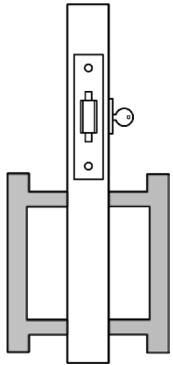

2001ADAP-1 SINGLE CYLINDER SET

Solution includes:
2001SDL-1 Sliding Door Lock.

Pair of Back-to-Back 7200P Pulls.

Less cylinder.

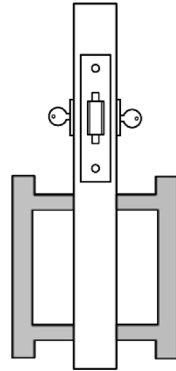

2001ADAP-2 DOUBLE CYLINDER SET

Solution includes:
2001SDL-2 Sliding Door Lock.

Pair of Back-to-Back 7200P Pulls.

Less cylinders.

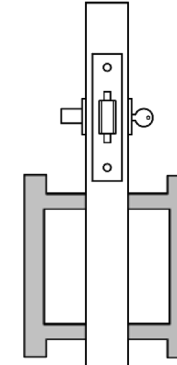

2001ADAP-3 ENTRY SET

Solution includes:
2001SDL-3 Sliding Door Lock.

7200ADA Thumb Turn.

Pair of Back-to-Back 7200P Pulls.

Less cylinder.

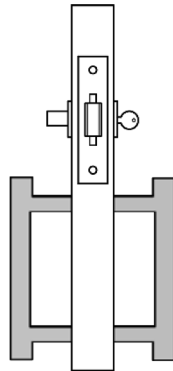

2001ADAP-3ST CLASSROOM DEADLOCK SET

Solution includes:
2001ST Classroom Deadlock (set can be
locked with a key).

7200ADA Thumb Turn.

Pair of Back-to-Back 7200P Pulls.

Less cylinder.

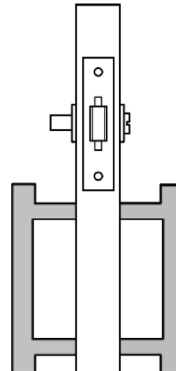

2001ADAP-5 PRIVACY SET

Solution includes:
2001SDL-5 Sliding Door Lock.

7200ER Emergency Coin Release.

7200ADA Thumb Turn.

Pair of Back-to-Back 7200P Pulls.

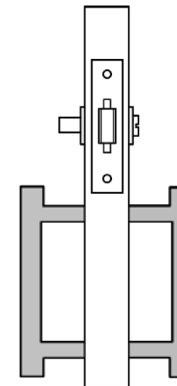

2001ADAP-5i PRIVACY SET WITH INDICATOR

Solution includes:
2001SDL-5 Sliding Door Lock.

7200ERi Emergency Coin Release with
Indicator.

7200ADA Thumb Turn.

Pair of Back-to-Back 7200P Pulls.

2001ADAP SLIDING DOOR HARDWARE SET

FURNISHED COMPLETE WITH LOCK + ADA TRIM

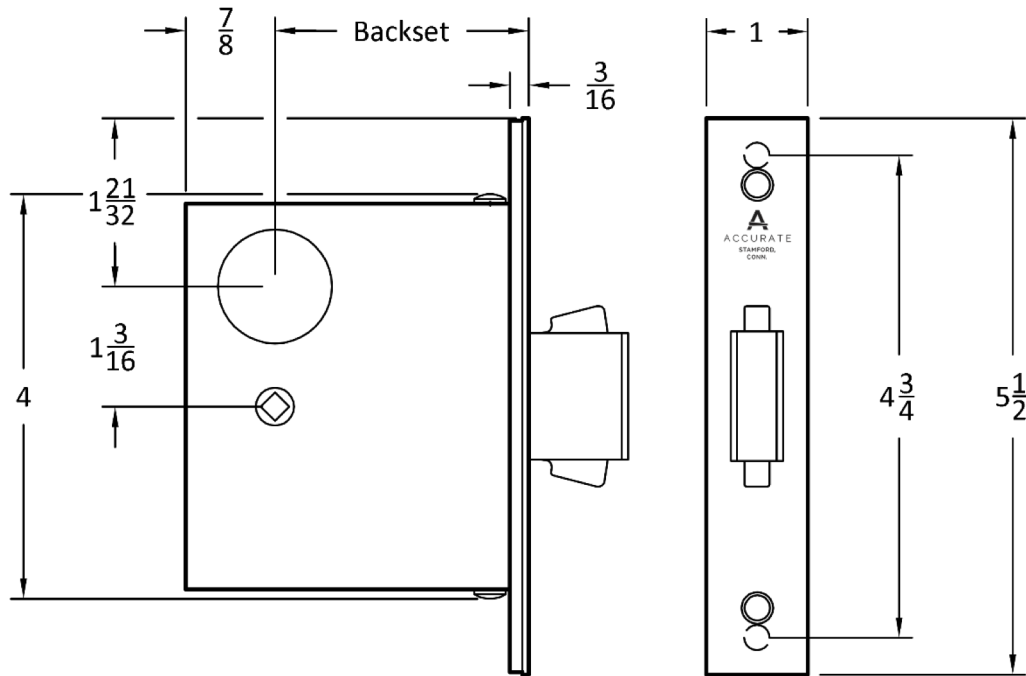

2001SDL SLIDING DOOR LOCK

BACKSET: $2\frac{1}{2}$ " , $2\frac{3}{4}$ " standard
(other backsets available)

CASE: Heavy gauge, stainless steel

ARMOR FRONT: Brass, bronze, or stainless steel, finished as required.

DEADBOLT: $\frac{1}{2}$ " thick, $1\frac{7}{32}$ " high, 1" throw

STRIKE: $3\frac{1}{2}$ " x 1" deadlock type standard
(Custom strike for barn doors/wall-mounted sliding doors available as a special order)

DUST BOX: Brass, stainless steel or oil rubbed bronze

CYLINDER: Available to order $\frac{3}{4}$ " 1", $1\frac{1}{8}$ " length in limited keyways (not included)

2001ADAP SLIDING DOOR HARDWARE SET

ADA COMPLIANT TRIM (INCLUDED BASED ON FUNCTION)

7200ADA

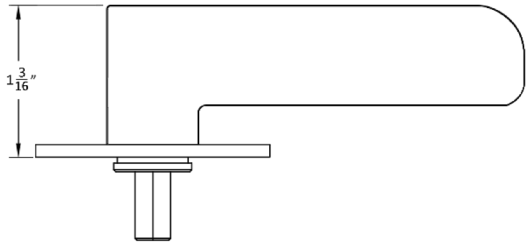
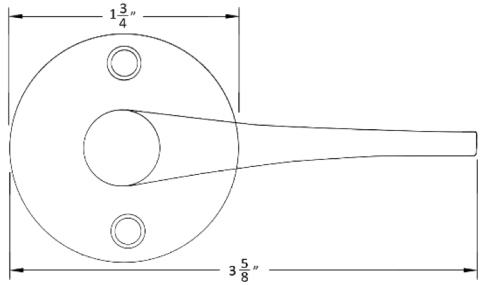

7200ER

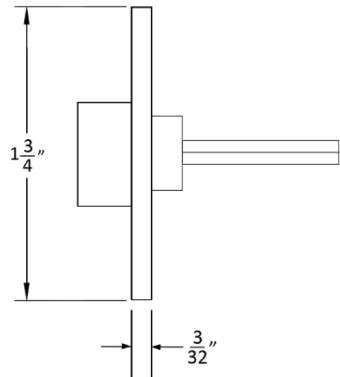
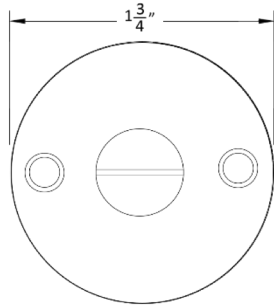

7200ERi

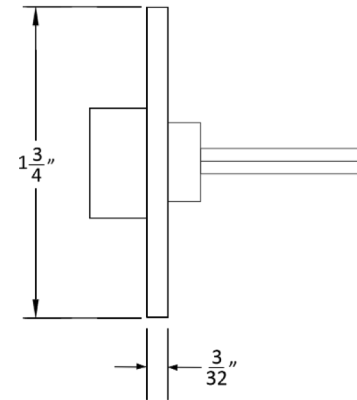
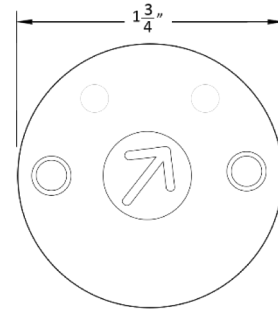

7200P PULLS

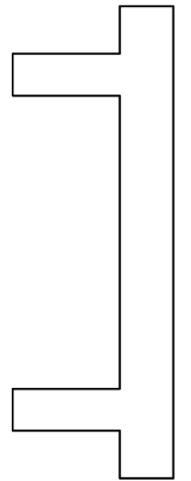
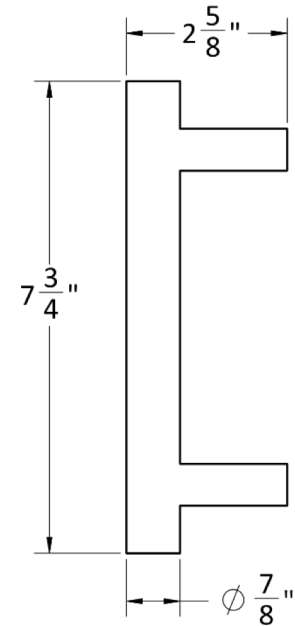

HOW TO SPECIFY

HANDING

Need to specify for functions with an indicator (2001ADAP-5i)

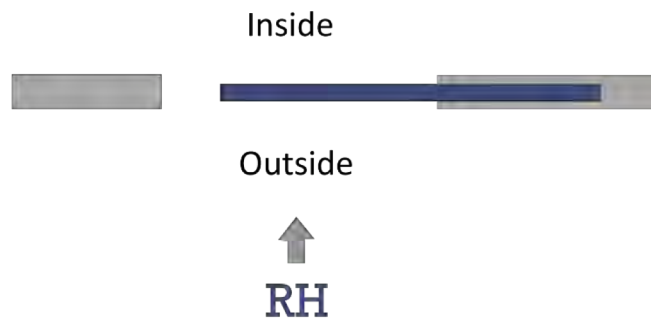

1. Standing outside
2. Opens to right

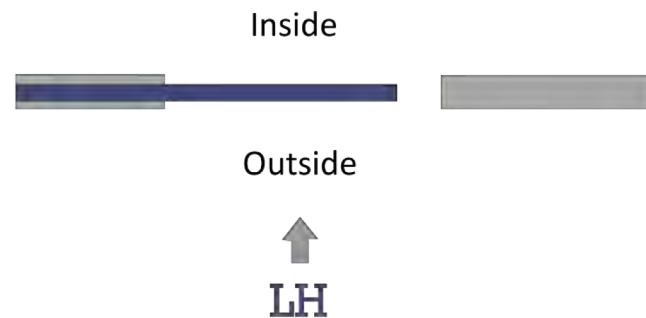

1. Standing outside
2. Opens to left

FINISHES

GROUP 1: US4, US4NL, US32D*, US26D*

GROUP 2: US3, US3NL, US26, US32, US9, US10, US10B, US14, US15, US19

GROUP 3: BN, BB, TN, TB, DURO, ESN, US15A, US5

* RMS Program only applies to standard US26D/US32D finishes.

To view example of finishes visit: [Accurate Finishes](#).

CYLINDERS & KEYING

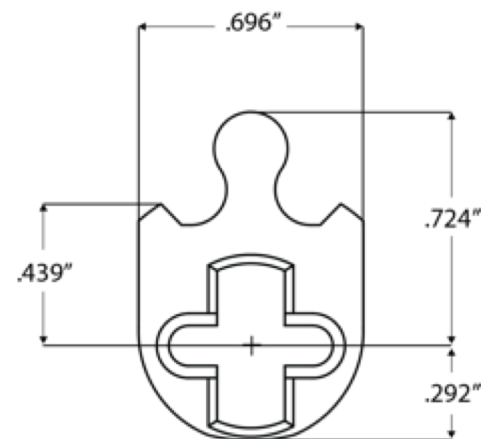

2001ADAP Sets accept any standard American mortise cylinder. For details on required cams and compatibility with other manufacturers' cylinders, please visit: [Accurate Support](#).

2001ADAP SLIDING DOOR HARDWARE SET SPECS

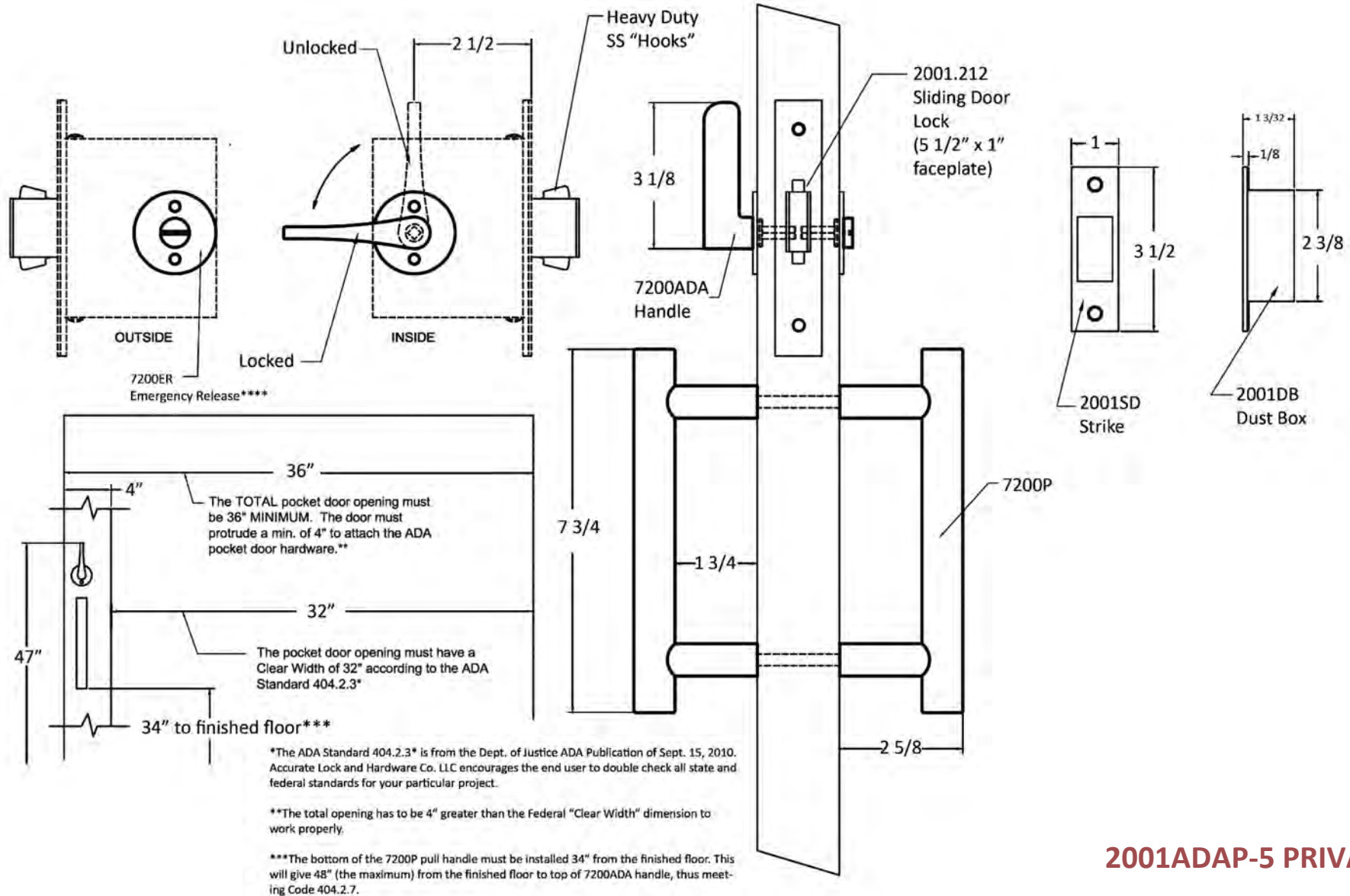

2001ADAP-5 PRIVACY SET SHOWN

HOW TO SPECIFY

FUNCTION.BACKSET.FINISH.HAND.DOORTHICKNESS

Functions

See available functions (pg. 3)

Backset

2¹/₂" or 2³/₄"
Other backsets
Available
(2", 3 ³/₄", 5" or 6")

Finishes

See available finishes
(pg. 6)
(RMS Program
US26D/US32D only)

Handing

Specify for 2001ADAP-5i
Privacy Indicator function
(only)

Door Thickness

1³/₈" or 1³/₄"
Other door thicknesses available
special order

EXAMPLES

Entry Set

E.g.: 2001ADAP-3.212.US26D.134

Privacy Set with Indicator

E.g.: 2001ADAP-5i.234.US19.RH.138

Privacy Set | RMS Program*

E.g.: RMS.2001ADAP-5.212.US26D/US32D.138

RMS Rapid Make + Ship Program

For more details see pg. 9-10.

Cylinders are not included. Please specify separately.

For barn door applications, please consider a 2001BSTK barn door strike (wall mounted), please call for details.

The "RMS" RAPID MAKE + SHIP PROGRAM

HOW TO SPECIFY

The RMS Program applies to the following sets in US26D/US32D finish:

- **RMS.2001ADAP-X.US26D/US32D**

QUANTITY

Limit 25 sets per order

SHIPPING

Orders received by 3pm EST, will be processed, made and shipped within 2 business days. (Shipping and handling charges are additional).

CONDITIONS

Add 20% to set cost.

Orders cannot be changed or cancelled. Doing so may result in a 45% restocking fee (refer to standard [Terms & Conditions](#)).

The RMS Program delivery commitment is intended to include only the products listed above. Any additions, modifications, and/or options outside of these guidelines will receive standard processing and lead-time.



**RMS.2001ADAP-5.US26D/US32D
PRIVACY SET**

RMS PROGRAM ORDER FORM

CUSTOMER INFO:

Name: _____
 Company: _____
 Street Address: _____
 City: _____ State: _____ Zip Code: _____
 Phone: _____
 Email: _____

SHIPPING ADDRESS (If Different):

Name: _____
 Company: _____
 Street Address: _____
 City: _____ State: _____ Zip Code: _____
 Phone: _____
 Email: _____

FUNCTION	BACKSET		FINISH	HANDING (For 2001ADAP-5i only)		DOOR THICKNESS		TOTAL QUANTITY (Limit 25 Sets Per Order)
	212	234		RH	LH	138DT	134DT	
2001ADAP-1 Single Cylinder	___	___	US26D/US32D	N/A	N/A	___	___	_____
2001ADAP-2 Double Cylinder	___	___	US26D/US32D	N/A	N/A	___	___	_____
2001ADAP-3 Entry	___	___	US26D/US32D	N/A	N/A	___	___	_____
2001ADAP-3ST Classroom Deadlock	___	___	US26D/US32D	N/A	N/A	___	___	_____
2001ADAP-5 Privacy	___	___	US26D/US32D	N/A	N/A	___	___	_____
2001ADAP-5i Privacy Indicator	___	___	US26D/US32D	___	___	___	___	_____

- SHIP VIA:**
- UPS 2 DAY.
 - UPS 3 DAY
 - UPS GROUND
 - FEDEX 1 NEXT DAY AIR
 - FEDEX 2 DAY
 - FEDEX 3 DAY
 - FEDEX GROUND SHIPPING

INDICATE CARRIER ACCOUNT NUMBER, IF DESIRED: _____

**ACCURATE LOCK & HARDWARE
MANUFACTURERS OF LOCKS AND
CUSTOM ARCHITECTURAL HARDWARE**

1 Annie Place | Stamford, CT 06902

P: 203.348.8865

F: 203.348.5234

E: sales@accuratelockandhardware.com

www.accuratelockandhardware.com

