

Marchio / Brand ZUCCHETTI

PAN

## PAN

ZP6319.190E 2 hole built-in single lever basin mixer.













2 hole built-in single lever basin mixer with aerator. Spout projection 6 7/8". Water flow restricted to 1,2 GPM.

R99815.190E

Rough-in



### Finiture / Finishes

	 C3	 C8	 C40	 C41	 C50	 C51
Chrome	Brushed Nickel	Polished Nickel	Gold	Brushed Gold	Metal Black	Brushed Metal Black
 W1	 N1	 N7				
Embossed Matt White	Embossed Matt Black	Soft Touch Black				

## PAN

ZP6319.190E Disegno Complessivo / Overall Drawing

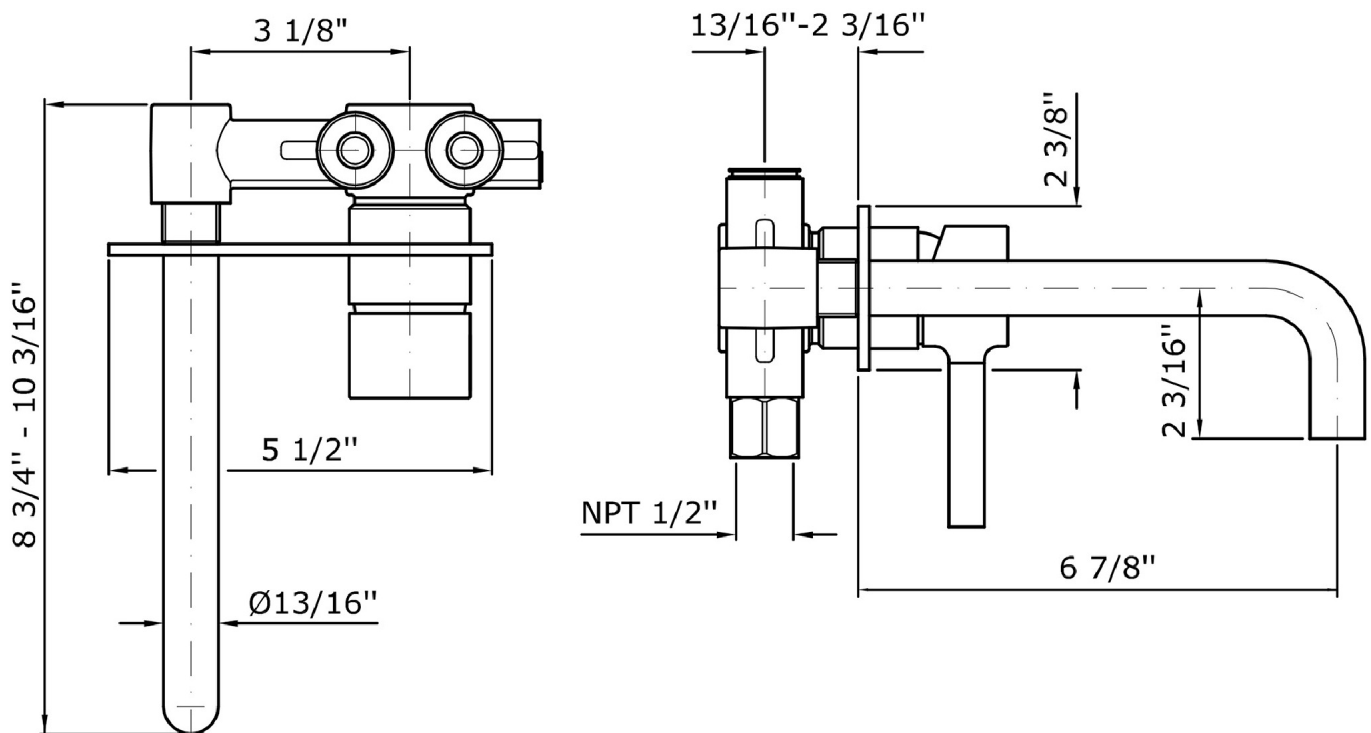

## PAN

ZP6319.190E Esplosi / Exploded

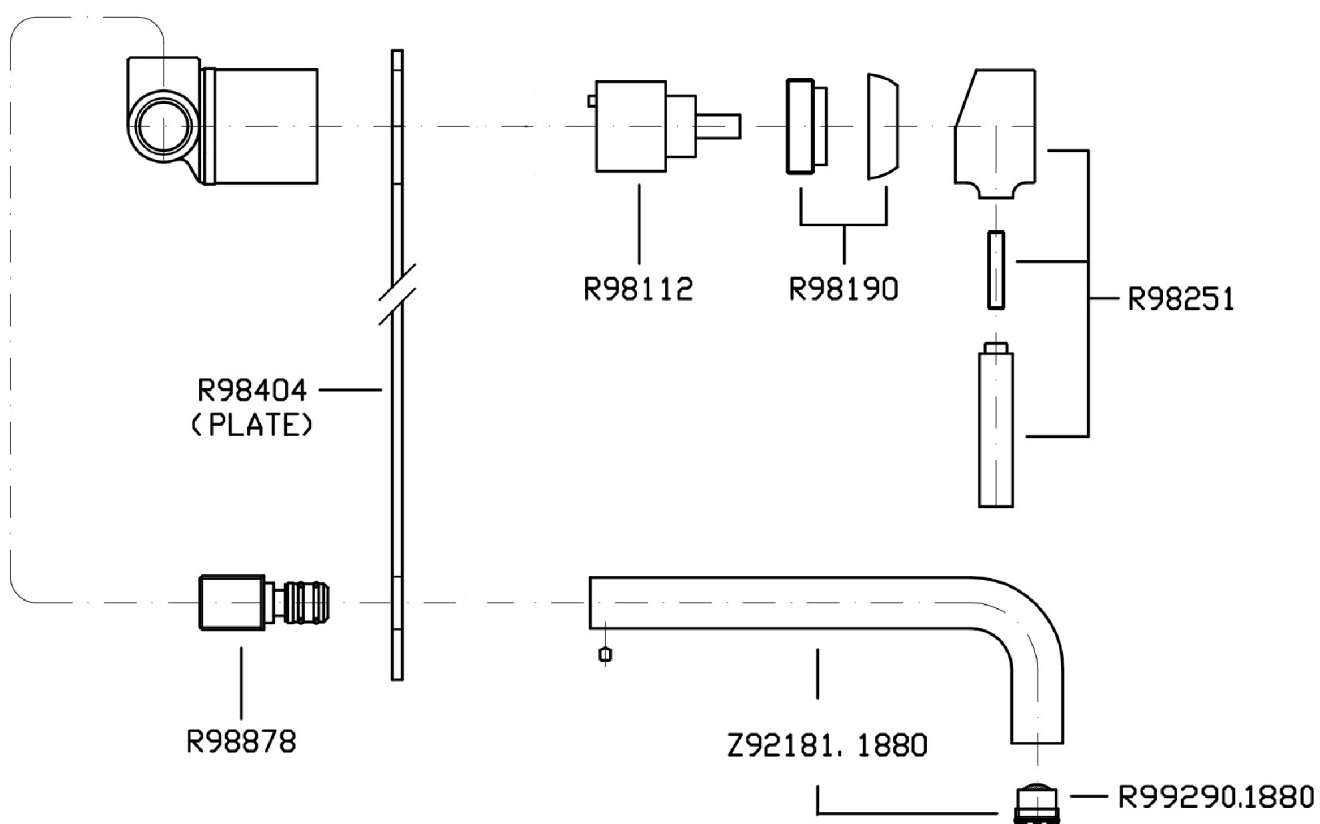

Marchio / Brand ZUCCHETTI

PAN

## PAN

ZP6319.190E Certificazioni / Certifications

USA

IAPMO

## PAN

ZP6319.190E Pesì e Misure / Weights and Sizes

Peso ( Kg ) Weight ( lb )	0,88 ( Kg )	1,94 ( lb )
Volume test ( dc3 ) - ( in3 )	3,32 ( dc3 )	202,60 ( in3 )
h ( mm ) - ( in )	93,00 ( mm )	3,66 ( in )
L1 ( mm ) - ( in )	162,00 ( mm )	6,38 ( in )
L2 ( mm ) - ( in )	220,00 ( mm )	8,66 ( in )

